

TBM-2-G7

E20 10R-04 3695

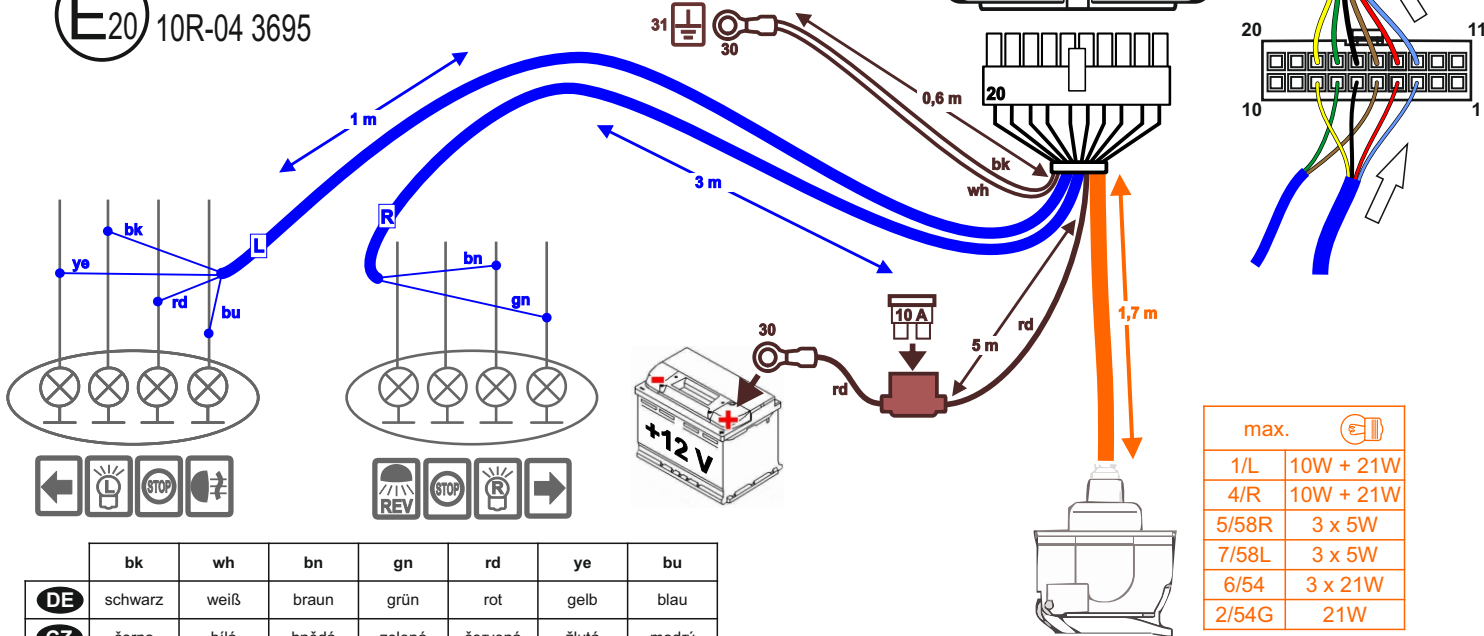

	bk	wh	bn	gn	rd	ye	bu
DE	schwarz	weiß	braun	grün	rot	gelb	blau
CZ	černo	bílá	hnědá	zelená	červená	žlutá	modrý
SK	čierny	biely	hnedý	zelený	červený	žltý	modrý
ES	negro	blanco	marrón	verde	rojo	amarillo	azul
FR	noir	blanc	marron	vert	rouge	jaune	bleu
GB	black	white	brown	green	red	yellow	blue
GR	μαύρο	λευκό	καφέ	πράσινο	κόκκινο	κίτρινο	μπλε
IT	nero	bianco	marrone	verde	rosso	giallo	blu
NO	svart	hvít	brun	grønn	rød	gul	blå
PL	czarny	biały	brązowy	zielony	czerwony	żółty	niebieski
RU	черный	белый	коричневый	зеленый	красный	желтый	голубой

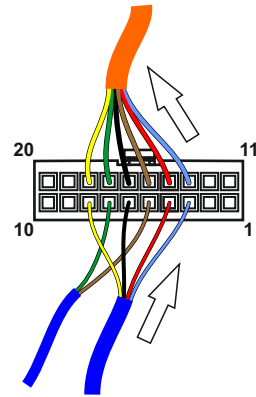
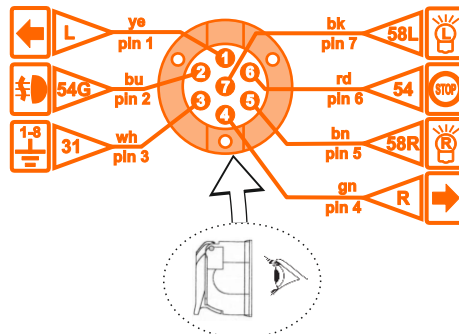

	max.
1/L	10W + 21W
4/R	10W + 21W
5/58R	3 x 5W
7/58L	3 x 5W
6/54	3 x 21W
2/54G	21W

TBM-2



bk

STEP 1 Output connections

G7



or

STEP 2 Input connections



bu

STEP 3 PWR connections

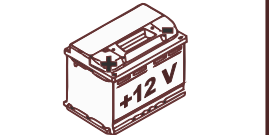

bn



PRODUCT VARIANTS

TBM-2



TBM-2-G7



TBM-2-G13-8



TBM-2-G13



ACCESSORIES

RJ11-LED-5



G13-POWER-KIT



	rd	pin 9
	rd/bk	pin 10
	wh	pin 11
	wh	pin 13

ICM
Intelligent Charger Module



> 13,2 V

DLI
Dual Lights Interface

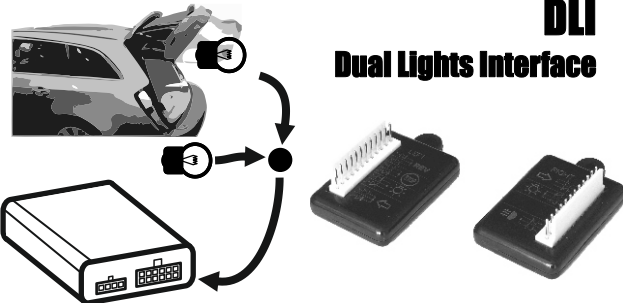

PDC-SWITCH-OFF
PDC-OFF

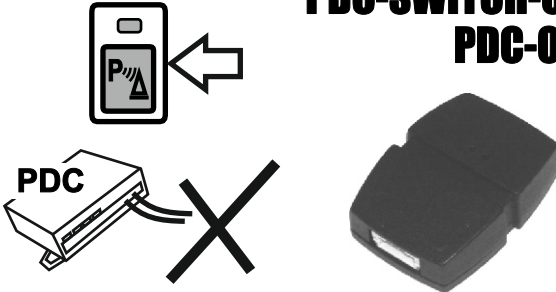

AUTOCAR-Ťažné zariadenia s.r.o.
Kocmál 460/22, Dolný Kubín 02601
8/5000, SLOVAKIA
phone +421 43 586 4864
email: autocar@taznezariadenia.sk
www.taznezariadenia.sk